



TEKTELIC Communications Inc.
7657 10th Street NE Calgary, Alberta
Canada, T2E 8X2

LoRA IoT AGRICULTURE SENSOR

User Guide

Document Type: User Guide

Document Number: T0005978_UG

Document Version: 1.9

Product Name: Agriculture Sensor

Product Code: T0005982 (Agriculture Sensor, Soil Surface Mount Module, NA)

T0005983 (Agriculture Sensor, Soil Surface Mount Module, EU)

T0005986 (Agriculture Sensor, Elevated Mount Module, NA)

T0005987 (Agriculture Sensor, Elevated Mount Module, EU)

Issue Date: April 5, 2021

PROPRIETARY:

The information contained in this document is the property of TEKTELIC Communications Inc. Except as specifically authorized in writing by TEKTELIC, the holder of this document shall keep all information contained herein confidential, and shall protect the same in whole or in part from disclosure to all third parties.

© 2019 TEKTELIC Communications Inc., all rights reserved.

All products, names, and services are trademarks and registered trademarks of their respective companies.

TEKTELIC Communications Inc.
7657 10th Street NE
Calgary, AB, Canada T2E 8X2
Phone: (403) 338-6900

Document Revision

Revision	Issue Date	Status	Editor	Comments
0.1	June 4, 2019	Initial Draft	Emma Tholl	First draft.
0.2	January 28, 2020	Draft	Mark Oevering	Numerous updates Updated part numbers in Table 1.
0.3	April 6, 2020	Release candidate	Mark Oevering	Updated document to new template. Update to Compliance statement.
1.0	April 16, 2020	Release	Mark Oevering	Changes to naming convention for modules.
1.1	April 16, 2020	Release	Conor Karperien	Updated table for default configuration.
1.2	April 20, 2020	Release	Mark Oevering	Added note about using the sensor in direct sunlight. Changed default configuration in Tables 3 & 4 as a result. Added more detail about how soil moisture is measured between the two modules.
1.3	May 14, 2020	Release	Mark Oevering	Refined statement about direct sunlight in overview section. Change to magnetic wake-up pattern.
1.4	May 27, 2020	Release	Zenon Herasymiuk	Added battery polarity statement on Section 1.3
1.5	July 7, 2020	Release	Mark Oevering	Added Watermark information in Overview section
1.6	July 22, 2020	Release	Mark Oevering	Clarifications to table for Figure 3, Page 9
1.7	September 28, 2020	Release	Mark Oevering	Added note regarding tape over battery for early versions of the Agriculture Sensor
1.8	December 16, 2020	Release	Mark Oevering	Corrections to Table 2
1.9	April 5, 2021	Release	Mark Oevering	Added ALS range to Table 2

Table of Contents

1	Product Description	6
1.1	Overview	6
1.2	Physical Interfaces.....	9
1.3	Specifications.....	10
2	Installation	12
2.1	Included Product and Installation Material	12
2.2	Safety Precautions.....	12
2.3	Unpacking and Inspection	12
2.4	Equipment Required for Installation.....	12
2.5	Elevated Mount Sensor Mounting	13
2.6	Cable Installation.....	13
3	Power Up, Commissioning and Monitoring	15
3.1	Reed Switch Awakening Procedure	15
3.2	Commissioning	17
4	Battery Replacement.....	18
5	Operation, Alarms, and Management.....	19
5.1	Configuration.....	19
5.2	Default Configuration.....	19
5.3	LED Behaviour	19
6	Compliance Statements.....	21

List of Tables

Table 1: Agriculture LoRa IoT Sensor Models	6
Table 2: Agriculture Sensor Specifications.....	10
Table 3: Default Configuration - Soil Surface Mount.....	19
Table 4: Default Configuration - Elevated Mount.....	19

List of Figures

Figure 1 Agriculture Sensor Soil Surface Mount Model.....	7
Figure 2 Agriculture Sensor Elevated Mount Model	8
Figure 3 Agriculture Sensor Connector Block	9
Figure 4 Mounting Holes.....	13
Figure 5 Reed switch location	16
Figure 6 Agriculture Sensor magnetic reset/wake-up pattern.....	16
Figure 7 Agriculture Sensor magnetic UL-triggering pattern.....	17
Figure 8 LED Location.....	20

1 Product Description

1.1 Overview

The Agricultural Sensor is a multi-purpose LoRaWAN IoT sensor intended for Agricultural use. The Sensor supports up to four Analog and Digital inputs allowing for the remote capture of data. The “Soil Surface Mount” model includes two metal probes; this addition uses two inputs. Table 1 presents the Agriculture Sensor models. Without the probes the device becomes the “Elevated Mount” model.

Table 1: Agriculture LoRa IoT Sensor Models

Product Code & Revision	Description	RF Region	Tx Band (MHz)	Rx Band (MHz)
T0005986	AGRICULTURE SENSOR, ELEVATED MOUNT MODULE, NA	US 902-928 MHz (ISM Band)	923-928	902-915
T0005987	AGRICULTURE SENSOR, ELEVATED MOUNT MODULE, EU	EU 863-870 MHz (ISM Band)	863-870	863-870
T0005982	AGRICULTURE SENSOR, SOIL SURFACE MOUNT MODULE, NA	US 902-928 MHz (ISM Band)	923-928	902-915
T0005983	AGRICULTURE SENSOR, SOIL SURFACE MOUNT MODULE, EU	EU 863-870 MHz (ISM Band)	863-870	863-870

The main features of the Agricultural Sensor are the following:

- **Temperature & Relative Humidity Sensor:** Reports temperature and relative humidity of the local environment. **PLEASE NOTE: PLACING THE UNIT IN DIRECT SUNLIGHT WILL RESULT IN THE SENSOR REPORTING CASE TEMPERATURE AND RELATIVE HUMIDITY INSTEAD OF TRUE AMBIENT CONDITIONS. PLACE THE UNIT OUT OF THE SUN FOR MORE ACCURATE AMBIENT TEMPERATURE AND RELATIVE HUMIDITY READINGS.**
- **Accelerometer:** High sensitivity device that can measure any shock or movement events. The primary purpose is to measure impact alarms.
- **Light Sensor:** Reports the amount of light in the local environment.
- **Battery Gauge:** Fuel gauges for non-rechargeable lithium batteries that can provide accurate results with ultra-low average power consumption.
- **Watermark Sensor:** Option to receive data on soil water tension. The Watermark is a resistive device that responds to changes in soil moisture. Once planted in the soil, it exchanges water with the surrounding soil thus staying in equilibrium with it. Soil water

is an electrical conductor thereby providing a relative indication of the soil moisture status. As the soil dries, water is removed from the sensor and the resistance measurement increases. Conversely, when the soil is rewetted, the resistance lowers. The relationship of ohms of resistance to centibars (cb) or kilopascals (kPa) of soil water tension is constant. The Watermark is calibrated to report soil water tension or matric potential, which is the best reference of how readily available soil water is to a plant. The raw data reported by the sensor for the watermarks is a frequency that increases as the watermark gets more saturated. Please refer to the TRM for information on how to convert the frequency to Soil Water Tension.

It should be noted that Watermark sensors need to be installed wet. If time permits, slowly wet the sensor by partially submerging (no more than half way) for 30 minutes in the morning and let dry until evening, wet for 30 minutes, let dry overnight, wet again for 30 minutes the next morning and let dry until evening. Soak over the next night and install WET. This will improve the sensor response.

There are several things to note regarding installation depending on the use case for the Watermark sensor. Please review “Sensor Installation” on Page 1 in the file “701 Meter Manual-WEB.pdf” file in the User Guide section of Agriculture Sensor in the Knowledge Base of the Tektelic Support Portal.

- **Soil Surface Mount Probe:** Option to measure soil moisture content and temperature. The probes work in a similar manner to the Watermark Sensor described above. There is no exchange of water with the surrounding soil, however. The probes simply measure how saturated and warm or cold the soil is that they are inserted into. The raw data provided by the sensor for soil moisture is a frequency. Please refer to the TRM for information on how to convert the frequency to Gravimetric Water Content.

Figure 1 illustrates the Agriculture Sensor **Soil Surface Mount** Model in the enclosure.

a) Exterior view



b) Inside view

Figure 1 Agriculture Sensor Soil Surface Mount Model

Figure 2 illustrates the Agriculture Sensor **Elevated Mount** Model in the Enclosure.

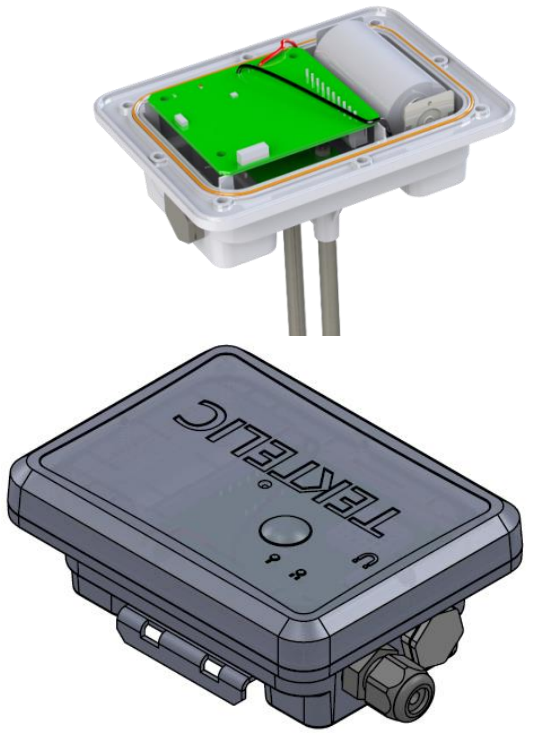

a) Exterior view

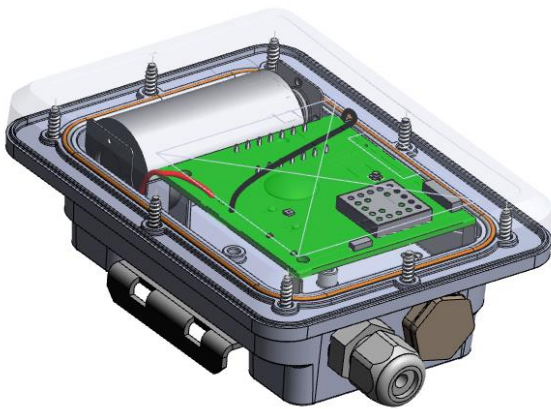

b) Inside view

Figure 2 Agriculture Sensor Elevated Mount Model

1.2 Physical Interfaces

Figure 3 below illustrates the customer accessible interfaces for the Agricultural Sensor. All models share the same layout.

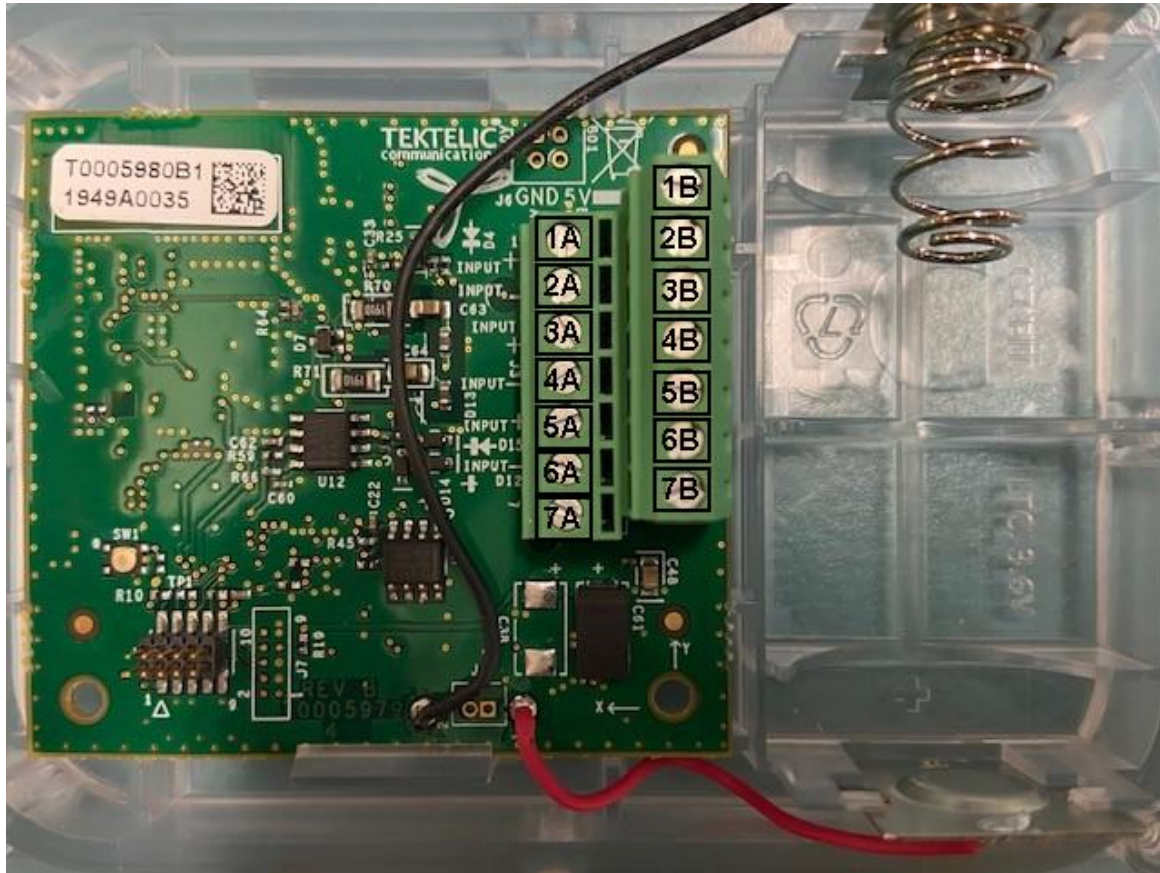

Legend:

1A = Input 2+ (**RES**)

2A = Input 2-

3A = Input 3 (Thermistor 1)*

4A = Input 3 (Thermistor 1)*

5A = Input 4 (Thermistor 2)*

6A = Input 4 (Thermistor 2)*

7A = GND (**RES**)

1B = Input 1+ (**RES**)

2B = Input 1-

3B = Moisture 1 (Watermark 1)*

4B = Moisture 1 (Watermark 1)*

5B = Moisture 2 (Watermark 2)*

6B = Moisture 2 (Watermark 2)*

7B = Power (**RES**)

RES = Reserved pins for Soil Surface Mount Module Only

***NOTE there is no polarity on either the Thermistors or Watermarks that are shipped in the kit with the Elevated Pole Module. The wires can be installed into the terminal block pins either way.**

Figure 3 Agriculture Sensor Connector Block

1.3 Specifications

The Agriculture Sensor specifications are listed in Table 2.

Table 2: Agriculture Sensor Specifications

Attribute	Specification
Use Environment	Outdoor
Environmental Rating	IP67
Operating Temperature	-40°C–85°C
Storage Temperature for Optimal Battery Life	-40°C–75°C
Operating Relative Humidity	0%–100%, condensing
Storage Relative Humidity	0%–100%, condensing
Size	Soil Surface Mount Sensor: 120 mm x 90 mm x 58 mm (H=161mm with probes) Elevated Mount Sensor: 120 mm x 90 mm x 47 mm
Weight	Soil Surface Mount Sensor: 224g Elevated Mount Sensor: 220g (233g with mounting plate)
Power Source	Battery powered: 1x C-cell Lithium Thionyl Chloride (LTC) 3.6V NOTE: If replacing the battery, please ensure it is inserted with the correct polarity.
Network technology/Frequency band	LoRaWAN in multiple variants (see Table 1): US 902-928 MHz, EU 863-870 MHz
Air Interface	LoRa
Battery Lifetime	At least 10 years with a baseline use case: transmission at maximum power every 15 minutes at room temperature
Maximum Tx Power	22 dBm
LED	Green: Joining the network activity Red: LoRa TX or RX activity
Sensing Functions	MCU temperature, ambient temperature, ambient humidity, ambient light, accelerometer, battery level, water tension, soil moisture, soil temperature
MCU Temperature Measurement Accuracy	< $\pm 5^{\circ}\text{C}$ between -40°C and 85°C

Ambient Temperature Measurement Accuracy	$\pm 0.2^{\circ}\text{C}$ and $\pm 2\%$ RH within temperature measurement range of -40°C to 125°C *
Ambient Light Range	0.01 to 65,535 lux
Soil Moisture, Input 1¹	1.33 – 1.37MHz
Soil Temperature, Input 2²	0.5 – 1.5V
Input 3 & 4³	0.3 – 2.5V
Watermark (Input 5 & 6)⁴	80 – 8000 Hz

*From the manufacturer datasheet.

¹ Applicable to Soil Surface Mount only

² Applicable to Soil Surface Mount only

³ Applicable to Elevated Pole only

⁴ Applicable to Elevated Pole only

2 Installation

2.1 Included Product and Installation Material

The following items are shipped with each sensor:

- LoRa IoT Agriculture Sensor with battery installed.
- A magnet to wake up the sensor from DEEP SLEEP.

2.2 Safety Precautions

The following safety precautions should be observed:

- The Agriculture Sensor is not a toy, KEEP AWAY FROM CHILDREN.
- Use only the specified Lithium Thionyl Chloride (LTC) cells.
- Do not exceed the maximum specified terminal voltages.
- All installation practices must be in accordance with the local and national electrical codes.
- Sensor inputs do not provide electrical isolation between each other.

2.3 Unpacking and Inspection

The following should be considered during the unpacking of a new Agriculture Sensor:

- Inspect the shipping carton and report any significant damage to TEKTELIC.
- Unpacking should be conducted in a clean and dry location.
- Do not discard the shipping box or inserts as they will be required if a unit is returned for repair or re-configuration.

2.4 Equipment Required for Installation

The following tools are required to install the Agriculture Sensor:

- Torx T10 screwdriver (8 x enclosure screws)
- Slotted screwdriver (internal terminal block connections)
- Wire Stripper
- Wire Cutter

2.5 Elevated Mount Sensor Mounting

On the Elevated Mount model of the Agriculture Sensor, there is a mounting bracket on the bottom of the unit. See Figure 4. These mounting holes can be used to screw the enclosure to a solid surface. The recommended mounting screw size is M3 or #6. Mounting screws are not provided with the sensor.

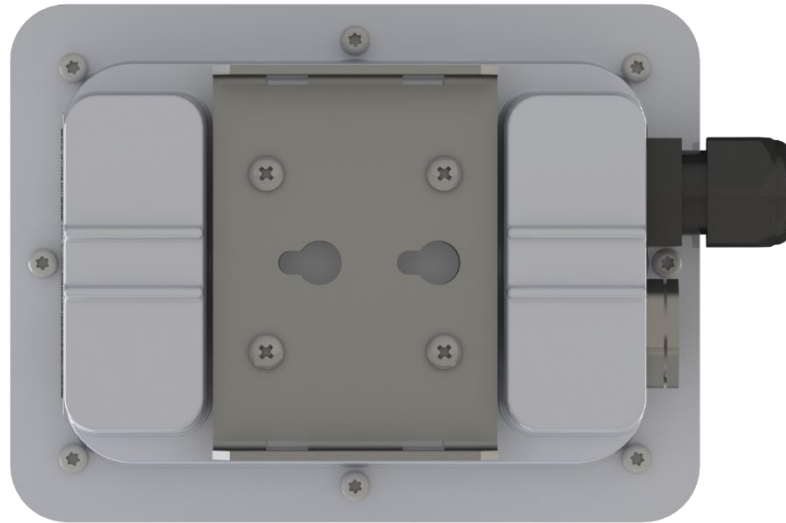

Figure 4 Mounting Holes

The mounting surface must be capable of holding > 2 kg [4.5 lbs]. Clearance must be provided for the modules cable gland and input cable.

2.6 Cable Installation

The Elevated Mount Sensor enclosure is provided with a waterproof cable gland through which all connections must be routed. The supplied cable gland size is PG-7. This gland supports cables with a jacket outside diameter of 3.0 mm to 4.3 mm (0.118" to 0.169").

The I/O terminal blocks accept 30-16 AWG wire. Select a cable that meets the application requirements and local and national electrical codes.

Figure 3 shows the terminal block wiring connections. To install the cable, first make the appropriate connections between the input cable and the terminal block. Next dress the internal wires so that the cable gland seals against the outer cable jacket. Finally, tighten the cable gland.

See Figure 3 on Page 9 for input connections. Signal connections should be connected to the positive terminal (labeled '+'). Similarly, the return path should be connected to the negative terminal (labeled '-') of the matching I/O channel.

NOTE: Elevated Mount Sensor I/O are referenced to the sensor ground and are not isolated.

3 Power Up, Commissioning and Monitoring

3.1 Reed Switch Awakening Procedure

Note: Early versions of the Agriculture Sensor were shipped with tape over the positive terminal of the battery, so if the wakeup pattern described below doesn't work, the battery should be checked and tape removed if necessary.

The Agriculture Sensor is equipped with a magnetic reed switch. The reed switch can be operated by the provided magnet, and is used for the following purposes:

- 1) MCU reset upon observing a specified magnetic pattern:

This is mainly used to wake up the module from DEEP SLEEP and having it try to join the network. When the module comes out of the factory, it is in the DEEP SLEEP mode,⁵ and can be activated using the specified magnetic pattern. Also, the same magnetic pattern can just be used to reset the Agriculture Sensor during normal operation, getting it to try to rejoin the network.

The magnetic pattern in this application is hard coded (not user configurable) as illustrated in Figure 5. A magnet presence is achieved by attaching the magnet to the enclosure at the magnet sign. A magnet absence is achieved by taking the magnet away from the enclosure. The magnet sign is illustrated in Figure 5 below:

⁵ The Agriculture Sensor will go to DEEP SLEEP whenever the internal sleep button on the PCBA (labeled SW1) is pressed. This is performed as the last step in the factory before closing the enclosure. The only ways to activate the module out of DEEP SLEEP is to apply the specified magnetic pattern or to open the enclosure and remove and reinsert the battery.

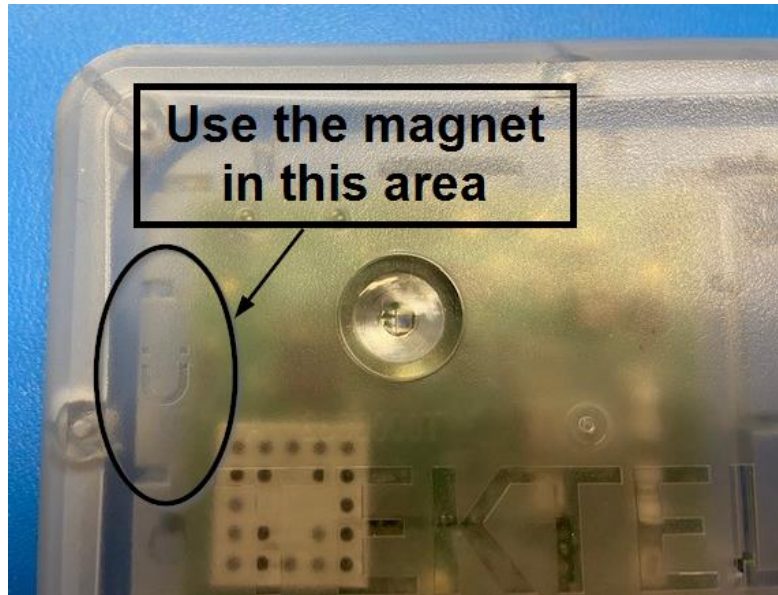

Figure 5 Reed switch location

Here are the steps as illustrated in Figure 6:

1. Attach the magnet to the enclosure at the magnet sign, and hold it for at least 3 sec but less than 10 sec.
2. Keep the magnet away for at least 3 sec.

As soon as the specified magnetic pattern is applied to the Agriculture Sensor, the Agriculture Sensor is reset and tries to join the network. It may take about 10 sec from the Agriculture Sensor reset to seeing the LED activity showing join attempts. Therefore, as step 1 in the above is completed, it takes about 13 seconds before observing the LED activity (if step 2 is respected).

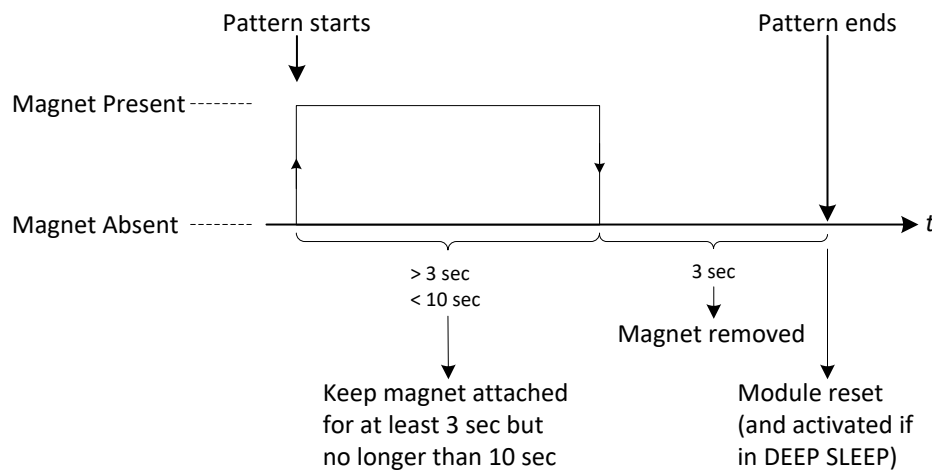

Figure 6 Agriculture Sensor magnetic reset/wake-up pattern

- 2) Triggering the Agriculture Sensor to uplink something upon observing a magnetic pattern:

This is used to get the LoRaWAN Class-A Agriculture Sensor to open a receive window so it can receive DL commands from the NS, or simply to trigger the Agriculture Sensor to uplink some desired transducer data.

The magnetic pattern in this case is not user configurable, and involves attaching and taking away the magnet to and from the magnet sign at the top of the enclosure once, all in less than 2 sec, as shown in Figure 6. It is important to note here that mistakenly holding the magnet attached to the module for more than 3 sec may trigger a module reset, as explained in item 1.

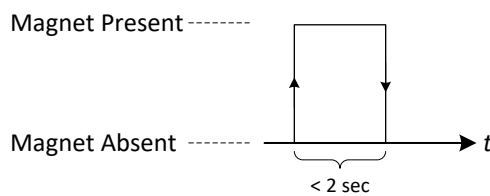

Figure 7 Agriculture Sensor magnetic UL-triggering pattern

Note: Replacing the batteries of the Agriculture Sensor does not cause the Agriculture Sensor to go to DEEP SLEEP. As soon as a new battery is inserted, the Agriculture Sensor boots up and tries to join a LoRaWAN network.

3.2 Commissioning

To add your sensor to the Network Server, you will need to enter the DevEUI, AppEUI and AppKey that were provided for your device from Tektelic.

4 Battery Replacement

Open up the Agriculture Sensor using a #10 Torx screwdriver. The Agriculture Sensor has 8x enclosure Torx screws at the bottom. Be careful not to misplace the silicone cover gasket from the top lid.

Replace the battery. The Agriculture Sensor accepts C-size, 3.6 V, LTC batteries. The allowed replacement batteries are as follows:

- Xeno Energy, part number: XL-145F
- Tadiran Battery, part number TL-4920/S
- Tadiran Battery, part number TL-5920/S

Once the Agriculture Sensor is powered and tries to join (see Section 5.3 for LED behavior), replace the cover and gasket. Make sure that the gasket is properly seated in the cover before placing on the Agriculture Sensor housing. Tighten the 8 cover screws to 2.5 lbf-in (30 N-cm).

5 Operation, Alarms, and Management

5.1 Configuration

The Agriculture Sensor supports a full range of Over-the-Air (OTA) configuration options. Specific technical details are available in the Agriculture Sensor Technical Reference Manual. All configuration commands need to be sent OTA during a sensor's downlink windows.

5.2 Default Configuration

The default configuration of the **Soil Surface Mount** Sensor for reporting transducer readings includes the following:

Table 3: Default Configuration - Soil Surface Mount

Seconds per Core Tick	900 (15 min)
Ticks per battery voltage measurement	96 (24-hours)
Ticks per Ambient Temperature	1 (15 min)
Ticks per Ambient Relative Humidity	1 (15 min)
Ticks per Soil Moisture	1 (15 min)
Ticks per Soil Temperature	1 (15 min)
Ticks per Ambient Light	1 (15 min)

The default configuration of the **Elevated Mount** Sensor for reporting transducer readings includes the following:

Table 4: Default Configuration - Elevated Mount

Seconds per Core Tick	900 (15 min)
Ticks per battery voltage measurement	96 (24-hours)
Ticks per Watermark 1	1 (15 min)
Ticks per Watermark 2	1 (15 min)
Ticks per Ambient Light	1 (15 min)

5.3 LED Behaviour

The LED's are located on the top of the Agricultural Sensor. See Figure 8.

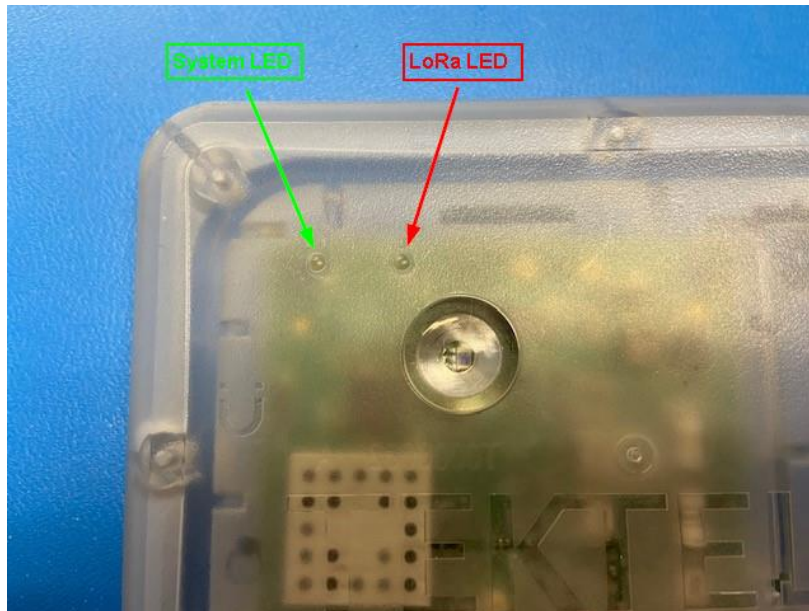

Figure 8 LED Location

During the boot and join procedure:

- Both LEDs will come on briefly when power is first applied.
- After a small delay (< 1 second) the LEDs will turn off and one of them will blink briefly.
 - If the System (green) LED blinks, then all health checks on the board have passed.
 - If the LoRa LED (red) blinks, then one of the health checks has failed. Consider replacing the battery, or moving the sensor to an environment within the temperature range.
- Immediately after the delay, the join procedure will begin. During the time the System LED will blink continuously until the sensor joins a network.
- The LoRa LED will now blink whenever LoRa activity occurs on the sensor (transmitting or receiving packets).

During normal operation:

- The LoRa LED will blink whenever LoRa activity occurs on the sensor (transmitting or receiving packets)
- The System LED can be controlled via the downlink command interface.

6 Compliance Statements

Federal Communications Commission

This device complies with Part 15 of the FCC Rules. Operation is subject to the following two conditions:

1. This device may not cause harmful interference, and
2. This device must accept any interference received, including interference that may cause undesired operation.

To comply with FCC exposure limits for general population / uncontrolled exposure, this device should be installed at a distance of 20 cm from all persons and must not be co-located or operating in conjunction with any other transmitter.

Changes or modifications not expressly approved by the party responsible for compliance could void the user's authority to operate the equipment. This equipment has been tested and found to comply with the limits for a Class A digital device, pursuant to Part 15 of the FCC Rules. These limits are designed to provide reasonable protection against harmful interference in an industrial installation. This equipment generates uses and can radiate radio frequency energy and, if not installed and used in accordance with the instructions, may cause harmful interference to radio communications. However, there is no guarantee that interference will not occur in a particular installation. If this equipment does cause harmful interference to radio or television reception, which can be determined by turning the equipment off and on, the user is encouraged to try to correct the interference by one of the following measures:

- Reorient or relocate the receiving antenna.
- Increase the separation between the equipment and receiver.
- Connect the equipment into an outlet on a circuit different from that to which the receiver is connected.
- Consult the dealer or an experienced radio/TV technician for help.

Innovation, Science and Economic Development Canada:

This device contains license-exempt transmitter(s)/receiver(s) that comply with Innovation, Science and Economic Development Canada's license-exempt RSS(s). Operation is subject to the following two conditions:

- (1) This device may not cause interference.
- (2) This device must accept any interference, including interference that may cause undesired operation of the device.

This device should be installed and operated with minimum distance 0.2 m from human body.

L'émetteur/récepteur exempt de licence contenu dans le présent appareil est conforme aux CNR d'Innovation, Sciences et Développement économique Canada applicables aux appareils radio exempts de licence. L'exploitation est autorisée aux deux conditions suivantes:

- a. L'appareil ne doit pas produire de brouillage.
- b. L'appareil doit accepter tout brouillage radioélectrique subi, même si le brouillage est susceptible d'en compromettre le fonctionnement.

Cet appareil doit être installé et utilisé à une distance minimale de 0.2 m du corps humain.

Proposition 65

 **WARNING:** This product can expose you to chemicals including lead, nickel & carbon black, which is known to the State of California to cause cancer, birth defects or other reproductive harm. For more information, go to www.P65Warnings.ca.gov.